

Gyproc MF fire performance ceiling

—
The monolithic fire rated
metal framing ceiling system



Gyproc MF fire performance ceiling

Gyproc MF fire performance ceiling is a suspended ceiling system with a fully concealed grid that can be used in conjunction with Gyproc plasterboards to create a seamless, monolithic appearance where fire performance is required.

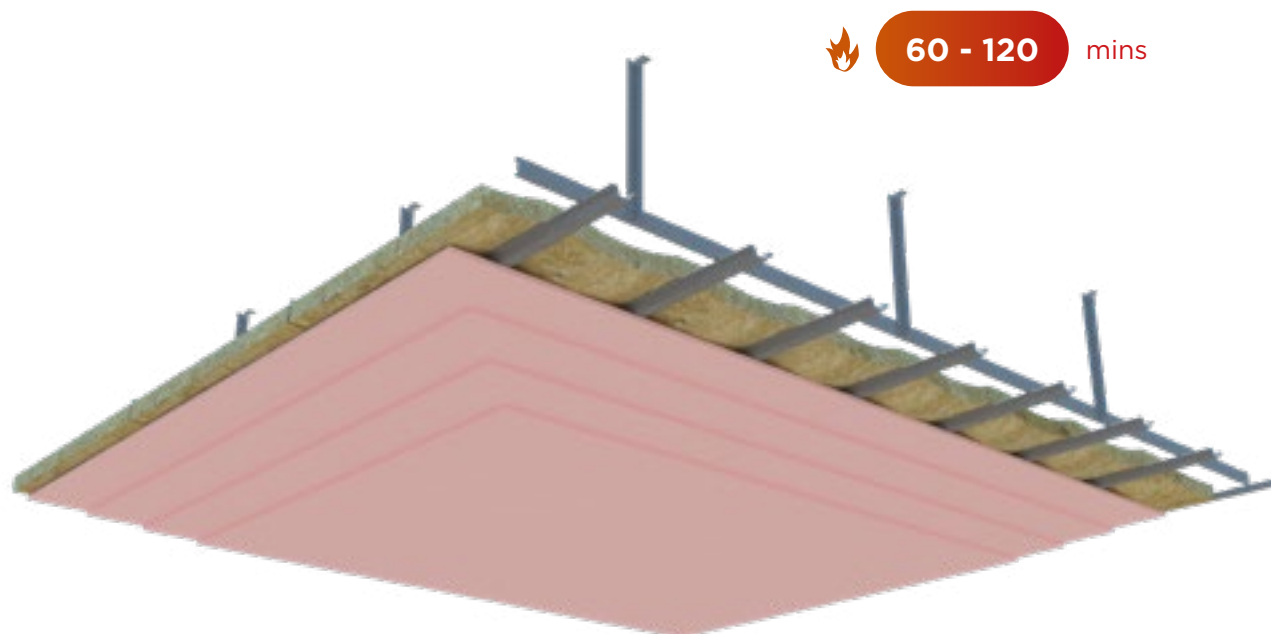

Key Benefits



Suitable for fire compartmentation in the building



Durable ceiling lining



Monolithic appearance



Ventilation ducts and other services accommodated in plenum



Suspension from concrete floors and purlins



Easy to create bulkheads and level change



Eligible for the SpecSure warranty from Gyproc

System components

Gypframe metal components



Gypframe MF5 Ceiling Section
Secondary section supported by Gypframe MF7, used to receive board lining



Gypframe GA1 Steel Angle
Primarily used as a perimeter wall angle and ceiling hanger in the Gyproc MF Ceiling system

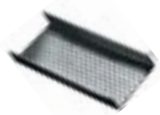

Gypframe MF7 Primary Support
Primary section to support Gypframe MF5 Ceiling Section



Gypframe Soffit Cleat with Nut & Bolt
Cleat for suspending MF ceiling Gypframe GA1 Steel Angle hangers from soffit

Board products



Gyproc FireStop^{1, 2, 3}
(12.5, 15mm)
Gypsum plasterboard with fire resistant additives

¹ Moisture resistant (MR) versions of the above boards are specified in intermittent wet use areas, e.g. shower cubicles

² Available with Activ'Air technology

³ Available with M2TECH technology



Fixing products



Gyproc Drywall Screws
Corrosion resistant self-tapping steel screws for fixing board to metal framing less than 0.8mm thick



Gyproc Waferhead Screws
Corrosion resistant self-tapping steel screws for fixing metal to metal framing less than 0.8mm thick



Gyproc Jack-Point Screws
Corrosion resistant self-drilling steel screws for fixing boards to Gypframe metal framing 0.8mm thick or greater



Gyproc Waferhead Jack-Point Screws
Corrosion resistant self-drilling steel screws for fixing metal to metal framing 0.8mm thick or greater and



Gyproc Wedge Anchor
Corrosion resistant anchor used for fixing fire rated partition and ceiling systems into masonry

System components (continued)

Plasterboard accessories



Gyproc Jointing Compound

Air-drying, asbestos free, ready mixed compound for filling and finishing plasterboard joints and corner beads



Gyproc Sealant

Used for sealing air paths to reduce air-leakage and optimise sound insulation performance



Gyproc Paper Tape

Designed for reinforcing flat joints when finishing plasterboard joints providing improved resistance against cracking

Corners



Gyproc Drywall Corner Bead

Provides corner reinforcement and protection to plasterboards and plasters



Levelline Flex

Adjustable corner reinforcement that flexes to any angle and gives high levels of impact protection



Gyproc Metal Corner Tape

High quality paper joint tape strengthened with two corrosion-resistant galvanised steel strips for the finishing of internal and external angles in drywall construction

Insulation products



KIMMCO ISOVER

Stone mineral wool

(50 and 70mm)*

For fire stopping, where required

Minimum density: 50 kg/m³

* Available in other thickness and density

Installation overview

Please refer to Gyproc MF ceiling installation guidelines for basic framing instructions.



Please note: Gypframe GA1 Perimeter Angle must be fixed to masonry backgrounds using Gyproc Wedge Anchors.



KIMMCO ISOVER Stone Mineral Wool insulation is laid over the back of the Gypframe MF5's.



Fix required layers of Gyproc FireStop plasterboard as per the reflected ceiling plan. Cover all Gyproc screws heads with Gyproc Jointing Compound.



Cover all joints with Gyproc Paper Tape and Gyproc Jointing Compound.

Table 1 – Gyproc MF fire protection to floor or roof cavity above suspended ceiling. Solutions to satisfy the requirements of ASTM E119

1

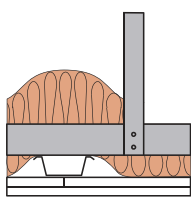

Gyproc MF suspended ceiling fixed to structure. Fixing centres for Gypframe MF5's and MF7's as per table below. 50mm stone mineral wool slab (50 kg/m³) laid over Gypframe MF5's. Ceiling linings as in table.

2

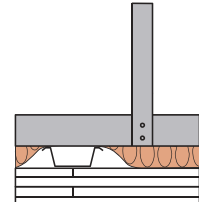

Gyproc MF suspended ceiling fixed to structure. Fixing centres for Gypframe MF5's and MF7's as per table below. 50mm stone mineral wool slab (50 kg/m³) laid over Gypframe MF5's. Ceiling linings as in table. The MF5's, MF7's and GA1's are 0.9mm gauge.

Detail	Board type	Ceiling lining thickness mm	MF5 support centres mm (gauge)	MF7 support centres mm (gauge)	Suspension - GA1 Hanger centres mm (gauge)	System weight kg/m ²
--------	------------	--------------------------------	-----------------------------------	-----------------------------------	---	------------------------------------

60 minutes fire resistance

1	FireStop	2 x 15	400 (0.5)	900 (0.5)	900 (0.5)	26
----------	----------	--------	-----------	-----------	-----------	----

120 minutes fire resistance

2	FireStop	4 x 15	400 (0.9)	900 (0.9)	900 (0.9)	49
----------	----------	--------	-----------	-----------	-----------	----

Table 2 – Gyproc MF fire protection to steel beams supporting concrete floors¹. Solutions to satisfy the requirements of BS 476: Part 23: 1987

1

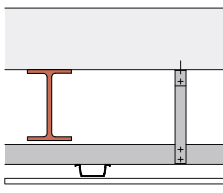

Gyproc MF ceiling suspended beneath steel beams supporting a concrete floor. Ceiling linings as in table.

2

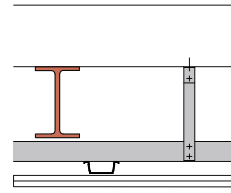

Gyproc MF ceiling suspended beneath steel beams supporting a concrete floor. Ceiling linings as in table.

Detail	Board type	Ceiling lining thickness mm	Approx. weight kg/m ²	MF5 support centres mm	MF7 support centres mm	Suspension - GA1 Hanger centres mm
--------	------------	--------------------------------	-------------------------------------	---------------------------	---------------------------	---------------------------------------

30 minutes fire resistance

2	Regular	2 x 12.5	18	400	1000	1000
----------	---------	----------	----	-----	------	------

60 minutes fire resistance

1	FireStop	1 x 12.5	11	400	1200	1200
----------	----------	----------	----	-----	------	------

120 minutes fire resistance

2	FireStop	2 x 15	25	400	900	900
----------	----------	--------	----	-----	-----	-----

¹ Concrete floors as described in BS 476: Part 23. The steel beams subjected to test had a section factor A/V (Hp/A) of 205m⁻¹ calculated on the basis of three sided profiled exposure. The suspended ceiling will also provide adequate protection to steel beams with a lower section factor.

NB The fire resistance and sound insulation performances are for imperforate partitions, walls and ceilings incorporating boards with all joints taped and filled according to Gyproc recommendations. The quoted performances are achieved only if Gyproc components are used throughout, and the company's fixing recommendations are strictly observed. Any variation in the specifications should be checked with the Gyproc Technical Team.

Table 3 – Maximum recommended loads on Gyproc MF Ceiling with 0.5mm suspension framework

Maximum load including weight of board and any insulation kg/m ²	Suspension - GA1 Hanger centres mm	MF7 channel centres mm
41.4	1000	600
37.8	900	900
24.4	1000	1000
19.1	900	1200
11.1	1200	1200
12.5 ²	1200	1200

Table 4 – Maximum recommended loads on Gyproc MF Ceiling with 0.9mm suspension framework

Maximum load including weight of board and any insulation kg/m ²	Suspension - GA1 Hanger centres mm	MF7 channel centres mm
66.2	900	900
107.4	800	800
184.8	700	700
294.8	600	600

NB Gypframe MF5 Ceiling Sections (0.9mm gauge) are installed at 400mm centres

NB Gypframe MF5 Ceiling Sections are installed at 400mm centres

Maximum loads are based on a limiting deflection of L/400, except for note ² which is based on L/360. Refer to **Products section - Boards** for weights of Gyproc plasterboards

Construction details - Double layer

1

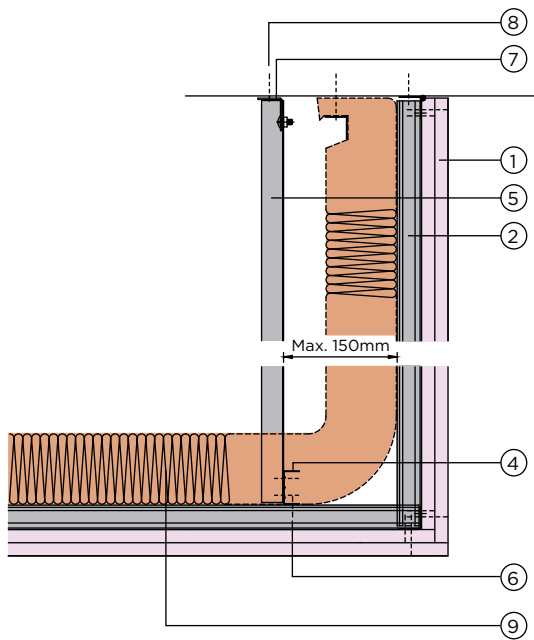

Bulkhead detail - 60 mins

2

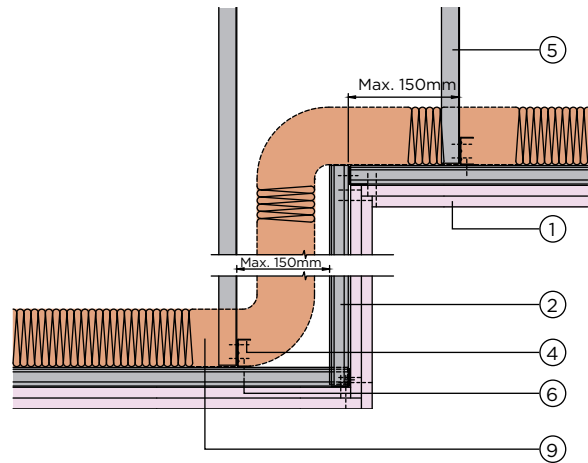

Change of level - 60 mins

3

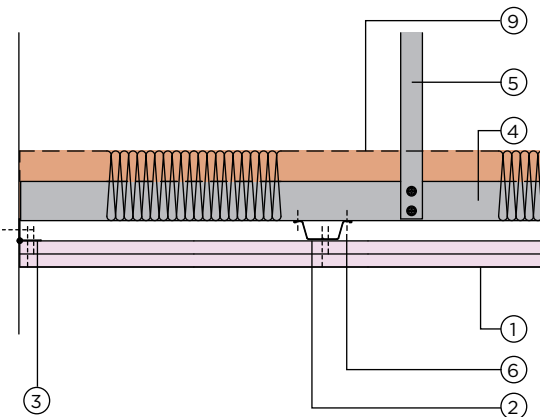

Perimeter detail parallel to Gyproframe MF5
- 60 mins

4

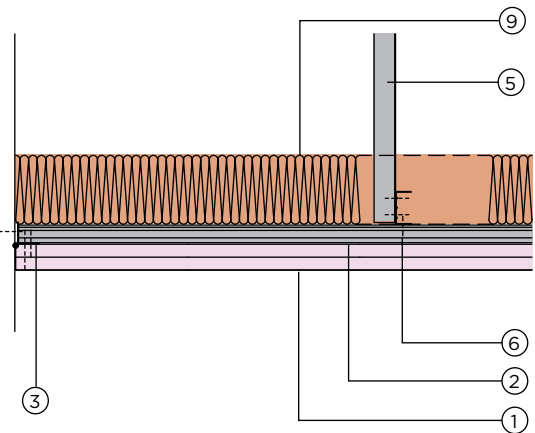

Perimeter detail perpendicular to Gyproframe MF5
- 60 mins

1. 15mm Gyproc FireStop
2. Gyproframe MF5 Ceiling Section
3. Gyproframe GA1 Perimeter Angle
4. Gyproframe MF7 Primary Support Channel

5. Gyproframe GA1 Steel Angle Hanger
6. Gyproc Waferhead Jack-Point Screws
7. Gyproframe Soffit Cleat with Nut & Bolt
8. Gyproc Wedge Anchor
9. 50mm Stone mineral wool (Density 50 kg/m³) by KIMMCO ISOVER

Construction details - Four layer

5

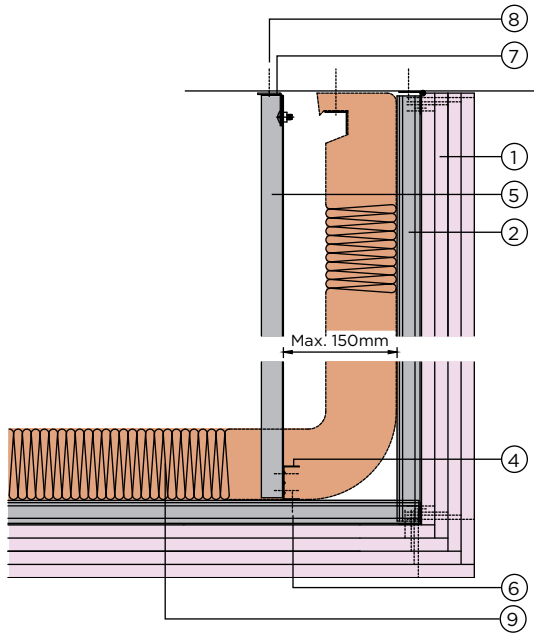

Bulkhead detail - 120 mins

6

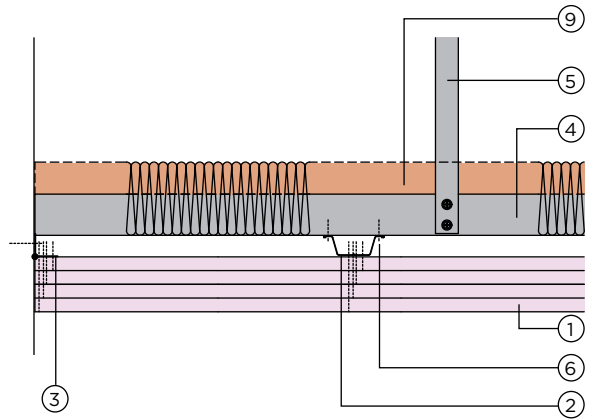

Perimeter detail parallel to Gypframe MF5
- 120 mins

7

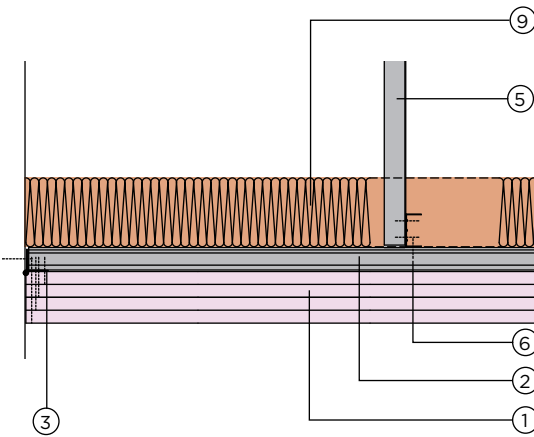

Perimeter detail perpendicular to Gypframe MF5
- 120 mins

1. 15mm Gyproc FireStop
2. Gypframe MF5 Ceiling Section (0.9mm thick)
3. Gypframe GA1 Perimeter Angle (0.9mm thick)
4. Gypframe MF7 Primary Support Channel (0.9mm thick)

5. Gypframe GA1 Steel Angle Hanger (0.9mm thick)
6. Gyproc Waferhead Jack-Point Screws
7. Gypframe Soffit Cleat with Nut & Bolt
8. Gyproc Wedge Anchor
9. 50mm Stone mineral wool (Density 50 kg/m³) by KIMMCO ISOVER

Construction details

8

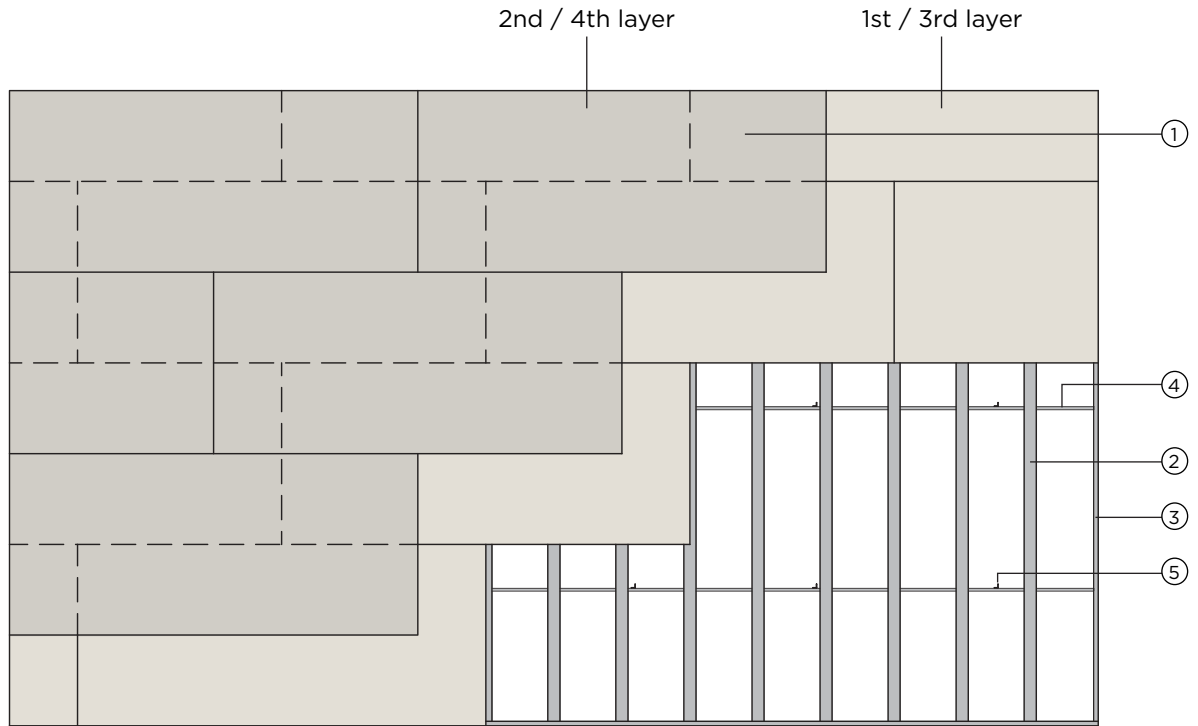

Reflected ceiling plan - 60 mins (double layer) and 120 mins (four layers)

1. 15mm Gyproc FireStop
2. Gypframe MF5 Ceiling Section
3. Gypframe GA1 Perimeter Angle
4. Gypframe MF7 Primary Support Channel
5. Gypframe GA1 Steel Angle Hangers