

GypWall™

HABITO

—

High strength partition systems with superior fixing capability



GypWall HABITO

GypWall HABITO offers complete freedom when it comes to adding fixtures to a partition. With high levels of impact resistance, durability and general robustness, GypWall HABITO gives superior performance over standard partitions. GypWall HABITO is based upon GypWall CLASSIC, but is also applied to other GypWall systems shown in this section, giving superior fixing capability with improved fire and acoustic performance and increased heights.



 **30 - 120** mins

 **36 - 62** R_w dB

 **37 - 63** STC dB

Key Benefits



Better acoustics



Fix anywhere without the need for additional pattring



Incredibly strong



Increased heights using Gyproc Habito plasterboard



Attack resistance



Reduced maintenance cycles due to a highly impact board surface



Eligible for the SpecSure warranty from Gyproc

System components

Gypframe metal components



Gypframe 'C' Studs

(50 S 50, 70 S 50, 92 S 50, 150 S 50)
Vertical stud providing acoustic and structural performances designed to receive fixing of board to both sides



Gypframe 'I' Studs

(70 I 70, 100 I 80, 150 I 90)
Enhanced strength stud that allows for increased partition height, designed to receive fixing of board



Gypframe AcouStud

(70 AS 50, 92 AS 50)
Vertical stud providing enhanced acoustic and structural performances designed to receive fixing of board to both sides



Gypframe Standard Floor & Ceiling Channels

(52 C 50, 72 C 50, 94 C 50, 102 C 50, 152 C 50)
Standard floor and ceiling channels for retaining Gypframe studs at floor and ceiling junctions and around openings to heights not exceeding 4200mm



Gypframe Deep Flange Floor & Ceiling Channels

(52 DC 60, 72 DC 60, 94 DC 60, 102 DC 60, 152 DC 60)
Floor and ceiling channels with deep flanges for retaining Gypframe studs at floor and ceiling junctions for partitions 4200mm to 8000mm high. Also used around openings and in deflection heads (maximum 30mm deflection)



Gypframe Extra Deep Flange Floor & Ceiling Channels

(52 EDC 80, 72 EDC 80, 94 EDC 80, 102 EDC 80, 152 EDC 80)
Floor and ceiling channels with extra deep flanges for retaining Gypframe studs at floor and ceiling junctions for partitions over 8000mm high. Also used around openings and in deflection heads (maximum 50mm deflection)



Gypframe 103 FC 50 Fixing Channel

A versatile metal fixing channel used to support medium weight fixtures on walls



Gypframe 103 FC 90 Fixing Channel

A versatile metal fixing channel used to support heavy weight fixtures on walls



Gypframe GFS1 Fixing Strap

Used to support horizontal board joints and within deflection head details



Gypframe GA4 Steel Angle

Widely used in framed construction to provide support, fixing and additional strength to penetrations. Also used as an angle to improve the fire and acoustic performance at deflection heads

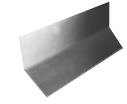

Gypframe GA6 Splayed Angle

Steel angle providing framing stability and board support



Gypframe Service Support Plate

For installation of 18mm plywood within a partition cavity to support medium to heavyweight fixtures

System components (continued)

Board products



Gyproc Regular^{1, 2, 3}
(12.5, 15mm)
Standard gypsum plasterboard



Gyproc SoundBloc^{1, 2}
(12.5, 15mm)
Gypsum plasterboard with a high density core for enhanced sound insulation performance



Gyproc FireStop^{1, 2, 3}
(12.5, 15mm)
Gypsum plasterboard with fire resistant additives



Gyproc Habito²
(12.5, 15mm)
Next generation plasterboard which consists of a specially reinforced gypsum core designed for high strength and fixing capability

¹ Moisture resistant (MR) versions of the above boards are specified in intermittent wet use areas, e.g. shower cubicles

² Available with Activ'Air technology

³ Available with M2TECH technology



Fixing products



Gyproc Habito Screws
Corrosion resistant self-tapping screw with counter sunk cross heads specifically used for fixing Gyproc Habito plasterboard to 'C' Stud and 'I' Stud



Gyproc Waferhead Jack-Point Screws
Corrosion resistant self-drilling steel screws for fixing metal to metal framing 0.8mm thick or greater and all 'I' studs



Gyproc Drywall Screws
Corrosion resistant self-tapping steel screws for fixing board to metal framing less than 0.8mm thick



Gyproc Wedge Anchor
Corrosion resistant anchor used for fixing fire rated partition and ceiling systems into masonry



Gyproc Waferhead Screws
Corrosion resistant self-tapping steel screws for fixing metal to metal framing less than 0.8mm thick



Gyproc Hammer Fix
Corrosion resistant nail, screw engaged in a nylon plug, suitable for fixing non fire rated partition systems and ceiling perimeters into masonry



Gyproc Jack-Point Screws
Corrosion resistant self-drilling steel screws for fixing boards to Gypframe metal framing 0.8mm thick or greater and all 'I' studs

System components (continued)

Plasterboard accessories



Gyproc Jointing Compound

Air-drying, asbestos free, ready mixed compound for filling and finishing plasterboard joints and corner beads



Gyproc Paper Tape

Designed for reinforcing flat joints when finishing plasterboard joints providing improved resistance against cracking



Gyproc FireStrip

Soft extruded linear gap seal for use within fire rated Gyproc system deflection head details



Gyproc Fibre Tape

Suitable for flat joint reinforcement



Gyproc Sealant

Used for sealing air paths to reduce air-leakage and optimise sound insulation performance

Corners



Habito Flex 83

Adjustable and superior corner reinforcement that uses structural laminate technology for ultimate impact protection



Levelline Flex

Adjustable corner reinforcement that flexes to any angle and gives high levels of impact protection



Gyproc Drywall Corner Bead

Provides corner reinforcement and protection to plasterboards and plasters



Gyproc Drywall Metal Edge Bead

A galvanised steel channel used to protect plasterboard edges and to form a defined edge commonly used around window reveals

Insulation products



ISOVER Eco Acoustic Partition Roll (APR) (25, 50, 75 and 100mm)*

Non-combustible glass mineral wool roll for sound insulation in partitions, linings and ceiling systems

Minimum density: 16 kg/m³



KIMMCO ISOVER Stone mineral wool (50 and 70mm)*

For fire stopping, where required

Minimum density: 33 kg/m³

* Available in other thickness and density

Installation overview



Gypframe Floor & Ceiling channels are fixed to the concrete substrate using Gyproc Wedge Anchors (for fire rated systems) or Gyproc Hammer Fix (for non-fire rated systems).



Gypframe 'C' Studs are suitably fixed to abutments. Gypframe 'C' Studs are fitted vertically to a friction fit within the channel sections to form the framework. Studs are fitted to all face the same way.



The perimeter of the metal framework is then sealed with Gyproc Sealant for optimum sound insulation performance.



ISOVER Eco APR is added to the partition cavity for increased acoustic performance.



Score and Snap

Gyproc Habito board is cut to length by first marking then scoring a line on the face side of the board with a straight edge and a construction use knife. Then, lift the sheet off the floor and snap Gyproc Habito board along the score line.

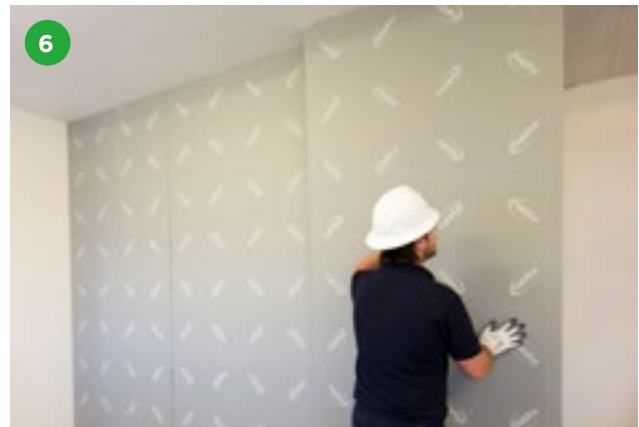

Gyproc Habito boards are screw-fixed to framing members to form the lining. Horizontal joints in face layer boards should be backed with Gypframe GFS1 Fixing Strap or stud noggings.

Table 1 – GypWall HABITO 50mm Gypframe ‘C’ Studs (50 S 50) - single layer board linings. Solutions to satisfy the requirements of BS 476: Part 22: 1987, ASTM E119 & ANSI / UL 263

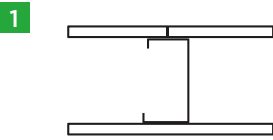

One layer of board each side of 50mm Gypframe ‘C’ Studs at 600mm centres. Linings as in table.

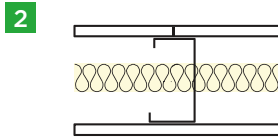

One layer of board each side of 50mm Gypframe ‘C’ Studs at 600mm centres. 25mm ISOVER Eco APR in the cavity. Linings as in table.

Detail	Partition thickness mm	Board type	Lining thickness mm	Maximum partition heights ¹ mm	Sound insulation		Duty rating	Approx. weight kg/m ²
					R _w dB	STC dB		

30 minutes fire resistance

1	77	Habito	1 x 12.5	3900	36	37	Severe	26
2	77	Habito	1 x 12.5	3900	43	46	Severe	26

60 minutes fire resistance

1	82	Habito	1 x 15	4200	37	38	Severe	30
2	82	Habito	1 x 15	4200	46	48	Severe	30

Table 2 – GypWall HABITO 50mm Gypframe ‘C’ Studs (50 S 50) - double layer board linings. Solutions to satisfy the requirements of BS 476: Part 22: 1987, ASTM E119 & ANSI / UL 263

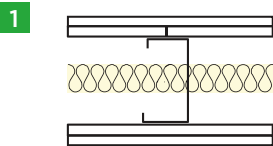

Two layers of board each side of 50mm Gypframe ‘C’ Studs at 600mm centres. 25mm ISOVER Eco APR in the cavity. Linings as in table.

Detail	Partition thickness mm	Inner Board type	Outer Board type	Maximum partition heights mm	Sound insulation		Duty rating	Approx. weight kg/m ²
					R _w dB	STC dB		

120 minutes fire resistance

1	102	1 x 12.5 FireStop	1 x 12.5 Habito	4300	50	52	Severe	48
---	-----	-------------------	-----------------	------	----	----	--------	----

¹Based on a limiting deflection of L/240 at 200 Pa. Greater heights can be achieved through the use of Gypframe ‘I’ Studs, or reduced stud centres. Refer to **Technical performance and principles of system design - Robustness** section for increased heights.

NB The fire resistance and sound insulation performances are for imperforate partitions, walls and ceilings incorporating boards with all joints taped and filled, according to Gyproc recommendations. The quoted performances are achieved only if Gyproc components are used throughout, and the company’s fixing recommendations are strictly observed. Any variation in the specifications should be checked with the Gyproc Technical Team.

NB For heights between 4200mm and 8000mm, Gypframe Deep Channels should be used at the base and at the head (subject to deflection head criteria).

NB Where tiling, refer to ‘Tiling section’ on page 304

Table 3 – GypWall HABITO 70mm Gypframe ‘C’ Studs (70 S 50) - single layer board linings. Solutions to satisfy the requirements of BS 476: Part 22: 1987, ASTM E119 & ANSI / UL 263

1

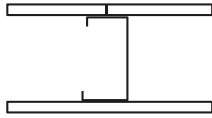

One layer of board each side of 70mm Gypframe ‘C’ Studs at 600mm centres. Linings as in table.

2

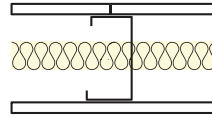

One layer of board each side of 70mm Gypframe ‘C’ Studs at 600mm centres. 25mm ISOVER Eco APR in the cavity. Linings as in table.

3

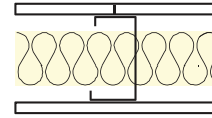

One layer of board each side of 70mm Gypframe ‘C’ Studs at 600mm centres. 50mm ISOVER Eco APR in the cavity. Linings as in table.

Detail	Partition thickness mm	Board type	Lining thickness mm	Maximum partition heights ¹ mm	Sound insulation		Duty rating	Approx. weight kg/m ²
					R _w dB	STC dB		

30 minutes fire resistance

1	97	Habito	1 x 12.5	4700	39	40	Severe	26
2	97	Habito	1 x 12.5	4700	45	47	Severe	27
3	97	Habito	1 x 12.5	4700	48	50	Severe	27

60 minutes fire resistance

1	102	Habito	1 x 15	4800	40	41	Severe	30
2	102	Habito	1 x 15	4800	45	46	Severe	31
3	102	Habito	1 x 15	4800	48	49	Severe	31

¹Based on a limiting deflection of L/240 at 200 Pa. Greater heights can be achieved through the use of Gypframe ‘I’ Studs, or reduced stud centres. Refer to **Technical performance and principles of system design - Robustness** section for increased heights.

NB The fire resistance and sound insulation performances are for imperforate partitions, walls and ceilings incorporating boards with all joints taped and filled, according to Gyproc recommendations. The quoted performances are achieved only if Gyproc components are used throughout, and the company’s fixing recommendations are strictly observed. Any variation in the specifications should be checked with the Gyproc Technical Team.

NB For heights between 4200mm and 8000mm, Gypframe Deep Channels should be used at the base and at the head (subject to deflection head criteria).

NB Where tiling, refer to ‘Tiling section’ on page 304

Table 4 - GypWall HABITO 70mm Gypframe 'C' Studs (70 S 50) - double layer board linings. Solutions to satisfy the requirements of BS 476: Part 22: 1987, ASTM E119 & ANSI / UL 263

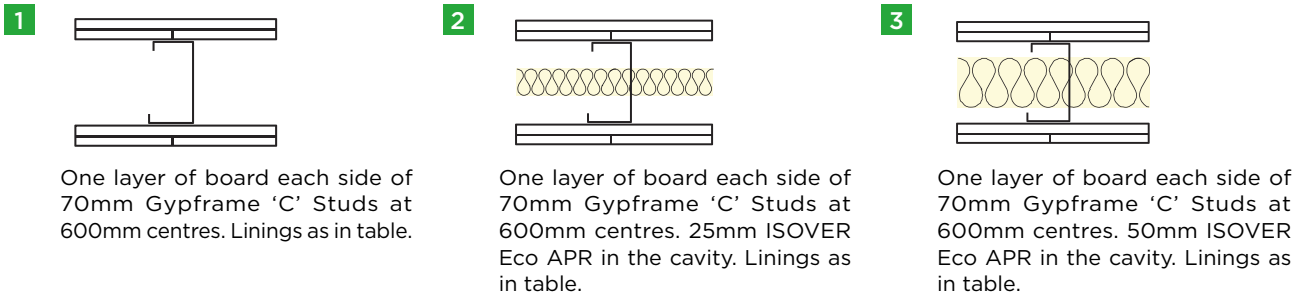

Detail	Partition thickness mm	Inner Board type mm	Outer Board type mm	Maximum partition heights mm	Sound insulation		Duty rating	Approx. weight kg/m ²
					R _w dB	STC dB		
60 minutes fire resistance								
1	122	1 x 12.5 Regular	1 x 12.5 Habito	5100	46	47	Severe	43
3	122	1 x 12.5 Regular	1 x 12.5 Habito	5100	54	55	Severe	44
90 minutes fire resistance								
2	132	1 x 15 Regular	1 x 15 Habito	5400	56	58	Severe	53
120 minutes fire resistance								
1	122	1 x 12.5 FireStop	1 x 12.5 Habito	5100	46	47	Severe	45
1	122	1 x 12.5 Habito	1 x 12.5 Habito	6200	48	47	Severe	50
3	122	1 x 12.5 FireStop	1 x 12.5 Habito	5100	53	55	Severe	46
3	122	1 x 12.5 Habito	1 x 12.5 Habito	6200	54	55	Severe	51
2	132	1 x 15 FireStop	1 x 15 Habito	5400	56	57	Severe	54

¹Based on a limiting deflection of L/240 at 200 Pa. Greater heights can be achieved through the use of Gypframe 'I' Studs, or reduced stud centres. Refer to **Technical performance and principles of system design - Robustness** section for increased heights.

NB The fire resistance and sound insulation performances are for imperforate partitions, walls and ceilings incorporating boards with all joints taped and filled, according to Gyproc recommendations. The quoted performances are achieved only if Gyproc components are used throughout, and the company's fixing recommendations are strictly observed. Any variation in the specifications should be checked with the Gyproc Technical Team.

NB For heights between 4200mm and 8000mm, Gypframe Deep Channels should be used at the base and at the head (subject to deflection head criteria).

NB Where tiling, refer to 'Tiling section' on page 304

Table 5 – GypWall HABITO 92mm Gypframe ‘C’ Studs (92 S 50) - single layer board linings. Solutions to satisfy the requirements of BS 476: Part 22: 1987, ASTM E119 & ANSI / UL 263

1

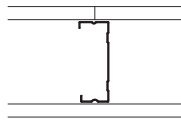

One layer of board each side of 92mm Gypframe ‘C’ Studs at 600mm centres. Linings as in table.

2

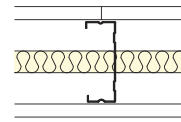

One layer of board each side of 92mm Gypframe ‘C’ Studs at 600mm centres. 25mm ISOVER Eco APR in the cavity. Linings as in table.

3

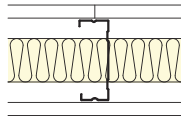

One layer of board each side of 92mm Gypframe ‘C’ Studs at 600mm centres. 50mm ISOVER Eco APR in the cavity. Linings as in table.

4

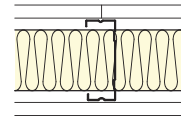

One layer of board each side of 92mm Gypframe ‘C’ Studs at 600mm centres. 75mm ISOVER Eco APR in the cavity. Linings as in table.

Detail	Partition thickness mm	Board type	Lining thickness mm	Maximum partition heights ¹ mm	Sound insulation		Duty rating	Approx. weight kg/m ²
					R _w dB	STC dB		

30 minutes fire resistance

1	119	Habito	1 x 12.5	5900	41	41	Severe	26
2	119	Habito	1 x 12.5	5900	48	46	Severe	27
3	119	Habito	1 x 12.5	5900	50	47	Severe	27
4	119	Habito	1 x 12.5	5900	52	49	Severe	27

60 minutes fire resistance

1	124	Habito	1 x 15	6100	40	41	Severe	30
2	124	Habito	1 x 15	6100	48	47	Severe	31
3	124	Habito	1 x 15	6100	51	49	Severe	31
4	124	Habito	1 x 15	6100	52	51	Severe	31

¹Based on a limiting deflection of L/240 at 200 Pa. Greater heights can be achieved through the use of Gypframe ‘I’ Studs, or reduced stud centres. Refer to **Technical performance and principles of system design - Robustness** section for increased heights.

NB The fire resistance and sound insulation performances are for imperforate partitions, walls and ceilings incorporating boards with all joints taped and filled, according to Gyproc recommendations. The quoted performances are achieved only if Gyproc components are used throughout, and the company’s fixing recommendations are strictly observed. Any variation in the specifications should be checked with the Gyproc Technical Team.

NB For heights between 4200mm and 8000mm, Gypframe Deep Channels should be used at the base and at the head (subject to deflection head criteria).

NB Where tiling, refer to ‘Tiling section’ on page 304

Table 6 - GypWall HABITO 92mm Gypframe 'C' Studs (92 S 50) - double layer board linings. Solutions to satisfy the requirements of BS 476: Part 22: 1987, ASTM E119 & ANSI / UL 263

1

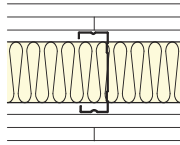

Two layers of board each side of 92mm Gypframe 'C' Studs at 600mm centres. 75mm ISOVER Eco APR in the cavity. Linings as in table.

Detail	Partition thickness mm	Inner Board type mm	Outer Board type mm	Maximum partition heights mm	Sound insulation		Duty rating	Approx. weight kg/m ²
					R _w dB	STC dB		

120 minutes fire resistance								
1	144	1 x 12.5 FireStop	1 x 12.5 Habito	6500	58	58	Severe	48

¹ Based on a limiting deflection of L/240 at 200 Pa. Greater heights can be achieved through the use of Gypframe 'I' Studs, or reduced stud centres. Refer to **Technical performance and principles of system design - Robustness** section for increased heights.

NB The fire resistance and sound insulation performances are for imperforate partitions, walls and ceilings incorporating boards with all joints taped and filled, according to Gyproc recommendations. The quoted performances are achieved only if Gyproc components are used throughout, and the company's fixing recommendations are strictly observed. Any variation in the specifications should be checked with the Gyproc Technical Team.

NB For heights between 4200mm and 8000mm, Gypframe Deep Channels should be used at the base and at the head (subject to deflection head criteria).

NB Where tiling, refer to 'Tiling section' on page 304

Table 7 – GypWall HABITO 92mm Gypframe AcouStuds (92 AS 50) - single layer board linings. Solutions to satisfy the requirements of BS 476: Part 22: 1987, ASTM E119 & ANSI / UL 263

1

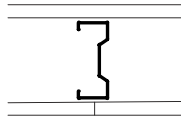

One layer of board each side of 92mm Gypframe AcouStuds at 600mm centres. Linings as in table.

2

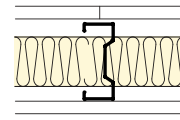

One layer of board each side of 92mm Gypframe 'C' Studs at 600mm centres. 75mm ISOVER Eco APR in the cavity. Linings as in table.

Detail	Partition thickness mm	Board type	Lining thickness mm	Maximum partition heights mm	Sound insulation		Duty rating	Approx. weight kg/m ²
					R _w dB	STC dB		

60 minutes fire resistance

1	124	Habito	1 x 15	4900	41	42	Severe	30
2	124	Habito	1 x 15	4900	53	51	Severe	30

Table 8 – GypWall HABITO 92mm Gypframe AcouStuds (92 AS 50) - double layer board linings. Solutions to satisfy the requirements of BS 476: Part 22: 1987, ASTM E119 & ANSI / UL 263

1

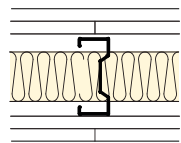

One layer of board each side of 92mm Gypframe 'C' Studs at 600mm centres. 75mm ISOVER Eco APR in the cavity. Linings as in table.

Detail	Partition thickness mm	Inner Board type	Outer Board type	Maximum partition heights mm	Sound insulation		Duty rating	Approx. weight kg/m ²
					R _w dB	STC dB		

120 minutes fire resistance

1	154	1 x 15 SoundBloc	1 x 15 Habito	6800	62 (53)	60	Severe	58
---	-----	------------------	---------------	------	---------	----	--------	----

¹ Based on a limiting deflection of L/240 at 200 Pa. Greater heights can be achieved through the use of Gypframe 'I' Studs, or reduced stud centres. Refer to **Technical performance and principles of system design - Robustness** section for increased heights.

NB The fire resistance and sound insulation performances are for imperforate partitions, walls and ceilings incorporating boards with all joints taped and filled, according to Gyproc recommendations. The quoted performances are achieved only if Gyproc components are used throughout, and the company's fixing recommendations are strictly observed. Any variation in the specifications should be checked with the Gyproc Technical Team.

NB For heights between 4200mm and 8000mm, Gypframe Deep Channels should be used at the base and at the head (subject to deflection head criteria).

NB Where tiling, refer to 'Tiling section' on page 304

GypWall HABITO - Extended applications

Where other GypWall systems are specified, and an improved level of fixing capability is required along with improved fire & acoustic performance, or increased heights are required, Gyproc Habito board may be used as an outer (or inner) lining board in lieu of the specified board type whilst still achieving the same, or increased levels of performance. The following pages provide details of this performance for both GypWall QUIET SF and GypWall QUIET systems lined with Gyproc Habito.

Note that at the time of writing, Gyproc Habito MR or M2TECH is not available. Where improved fixability is required and Gyproc Habito is preferred, then Habito may be used as the inner layer board keeping the specified MR or M2TECH grade board lining as the outer layer ensuring the specified moisture / mold & moisture performance of the partition is maintained.

For guidance on design considerations for these individual systems, please refer to the appropriate design section of relevant system type in this White Book.

**Table 9 - GypWall HABITO QUIET SF 70mm Gypframe 'C' Studs (70 S 50).
Solutions to satisfy the requirements of BS 476: Part 22: 1987, ASTM E119 & ANSI/UL 263**

1

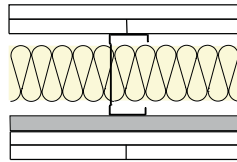

Two layers of board each side of 70mm Gypframe 'C' Studs at 600mm centres with Gypframe RB1 Resilient Bar at 600mm centres to one side. 50mm ISOVER Eco APR in the cavity. Linings as in table.

2

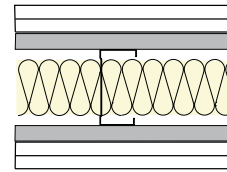

Two layers of board each side of 70mm Gypframe 'C' Studs at 600mm centres with Gypframe RB1 Resilient Bar at 600mm centres to both sides. 50mm ISOVER Eco APR in the cavity. Linings as in table.

Detail	Partition thickness mm	Inner Board type mm	Outer Board type mm	Maximum partition heights mm	Sound insulation		Duty rating	Approx. weight kg/m ²
					R _w (R _w +Ctr) dB	STC dB		

120 minutes fire resistance

1	137	1 x 12.5 FireStop	1 x 12.5 Habito	4400	59 (48)	60	Severe	52
2	152	1 x 12.5 FireStop	1 x 12.5 Habito	3800	61 (50)	62	Severe	52

¹ Based on a limiting deflection of L/240 at 200 Pa. Greater heights can be achieved through the use of Gypframe 'I' Studs. Refer to **Technical performance and principles of system design - Robustness** section for increased heights.

NB The fire resistance and sound insulation performances are for imperforate partitions, walls and ceilings incorporating boards with all joints taped and filled, according to Gyproc recommendations. The quoted performances are achieved only if Gyproc components are used throughout, and the company's fixing recommendations are strictly observed. Any variation in the specifications should be checked with the Gyproc Technical Team.

NB For heights between 4200mm and 8000mm, Gypframe Deep Channels should be used at the base and at the head (subject to deflection head criteria).

NB Where tiling, refer to 'Tiling section' on page 304

Table 10 - GypWall HABITO QUIET 50mm Gypframe 'C' Studs (50 S 50) with cross braces. Solutions to satisfy the requirements of BS 476: Part 22: 1987, ASTM E119, ANSI / UL 263

1

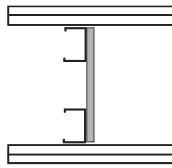

Two Gypframe 'C' Stud frameworks braced at max. 1200mm centres. Studs at 600mm centres. Linings as in table.

2

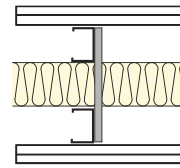

Two Gypframe 'C' Stud frameworks braced at max. 1200mm centres. Studs at 600mm centres. 50mm ISOVER Eco APR in the cavity. Linings as in table.

Detail	Partition thickness mm	Inner Board type mm	Outer Board type mm	Maximum partition heights mm	Sound insulation		Duty rating	Approx. weight kg/m ²
					R _w (R _w +Ctr) dB	STC dB		

120 minutes fire resistance

1	200	1 x 12.5 FireStop	1 x 15 Habito	9000	51	51	Severe	50
2	200	1 x 12.5 FireStop	1 x 15 Habito	9000	61 (49)	63	Severe	50
2	200	1 x 15 SoundBloc	1 x 15 Habito	9400	61 (50)	63	Severe	58

¹ Based on a limiting deflection of L/240 at 200 Pa. Greater heights can be achieved through the use of Gypframe 'I' Studs. Refer to **Technical performance and principles of system design - Robustness** section for increased heights.

² Increasing cavity width improves acoustic performance, especially at low frequencies (R_w + C_v)

NB The fire resistance and sound insulation performances are for imperforate partitions, walls and ceilings incorporating boards with all joints taped and filled, according to Gyproc recommendations. The quoted performances are achieved only if Gyproc components are used throughout, and the company's fixing recommendations are strictly observed. Any variation in the specifications should be checked with the Gyproc Technical Team.

NB For heights between 4200mm and 8000mm Gypframe Deep Channel should be used at the head and base. For heights in excess of 8000mm Gypframe Extra Deep Channel should be used at the base and at the head (subject to deflection head criteria).

NB Where tiling, refer to 'Tiling section' on page 304





Fixing Capability



Direct Fixing in Gyproc Habito boards:

Partitions can be made future proof by using Gyproc Habito boards. You can now fix heavy items directly into the board without using any specialist fixings or support. Gyproc Habito makes fixing cupboards, TV's, hospital screens, equipment and everyday objects like fire extinguishers, frames, curtain poles etc., very simple and secure.

Table 11 - Example fixing devices and typical safe working loads on Gyproc partitions, lining and ceiling Tab incorporating Habito

Fixing Type			Habito Layers	Typical SWL ¹ (typical failure load)
Detail	Description	Size		
	Woodscrew	No. 10 (5mm)	1 x 12.5mm	30kg (60kg) ²
			2 x 12.5mm	80kg (160kg) ²
	Steel expanding cavity fixing	M5 x 37	1 x 12.5mm	55kg (110kg)
		M5 x 65	2 x 12.5mm	60kg (120kg)
		M6 x 37	1 x 12.5mm	65kg (130kg)
		M6 x 65	1 x 12.5mm	65kg (130kg)

¹Safe Working Load (SWL) - a safety factor of 2 has been used

²A standard 5mm, single thread, No. 10 Woodscrew should be used. Other types of woodscrews can affect the safe working load.

NB The distance between screws used to support fixtures, as shown in this table, should be a minimum of 15mm apart. Fixings closer than this have poorer performance due to a breakdown of the plasterboard core.









NB Fixing screws can be taken out and then screwed back into the same hole without a decrease in pull out performance. This is because when first screwed in a thread is formed within the gypsum core. Re-inserting the screw uses the same thread and provides the same level of screw pull out performance up to a maximum of three times.

NB For GypWall QUIET SF, ensure that fixings do not bridge the Gypframe RB1 Resilient Bars, otherwise the acoustic performance will be compromised.

NB For technical assistance on above fixings please contact the fixings manufacturer. The suitability of the fixing must be confirmed by the building designer / fixing manufacturer.

NB The information within table 11 does not take into consideration any additional forces that may be applied, whether it be accidental, abusive or otherwise. The example fixing devices, typical safe working loads and typical failure loads given in table 11 relate to the installation of single fixtures. It is important to ensure that the drylining system specified is capable of supporting the loads, particularly if installing multiple fixtures. Furthermore, it may be necessary to incorporate several fixings per fixture to ensure the weight is distributed across the drylining system rather than a point load, particularly for medium to heavy fixtures.

Table 12 - Types of load applied to Gyproc partitions, lining and ceiling systems

Type of Load	Examples	Can Habito be used?
 Static Load/Dead Load	Any load that remains constant once imposed on the wall  	✓ Habito can be used for these types of load
 Cyclic Load	Any load that is gradually imposed and reduced  	✓ Habito can be used for these types of load
 Live Load/Dynamic Load	Any load that is imposed through human interaction  	We recommend the use of a secondary structure to support live loads

Design

Planning – key factors

GypWall HABITO follows Gyproc’s standard partition layouts but lines them with a unique plasterboard product which is designed to offer ultimate performance in fixability, impact resistance, fire and acoustic performance.

For guidance on design considerations for these individual systems, please refer to the appropriate design section of relevant system type in this White Book.

The following design guidance is specific to these systems lined with Gyproc Habito.

Tiling

Tiles up to 32 kg/m² can be applied to the surface of Gyproc Habito. Refer to Tiling on page 304 for further information.

Air quality

Consideration should be given to specifying plasterboard linings that, in addition to the performances listed in the preceding tables from page 124-131 (covering fire, acoustic, duty rating etc), actively absorb harmful volatile organic compounds (VOC’s) such as formaldehyde, from the atmosphere. Where additional protection against VOC’s is required, then Activ’Air versions of the boards listed in these pages should be specified – for example Gyproc Habito Activ’Air.

Using Activ’Air versions of any of the plasterboard linings listed in the performance tables, will not affect the fire, acoustic, height or robustness performances listed.

Fixtures

Due to the unique composition and inherent strength of Gyproc Habito, fixings can be made directly to the board. The patented reinforced core provides a high resistance against screw pull-out, and resists multiple fix and re-fix actions. Tests show that the same screw can be re-fixed into the same location seven times without adversely affecting the pull-out strength of the board as listed in the table below. In addition, fixings have been tested against screw pull-out as close as 15mm to an adjacent fixing under load.

GypWall HABITO has been designed to support the simple fixing of medium and heavy weight items such as shelves, cupboards, tv’s, fire extinguishers, curtain poles etc. without pre-planning at design stage where specialist metal fixing channels or plywood pattrressing is normally required.

This means that new layouts can be created, or existing layouts changed, simply and safely using a normal screwdriver and a simple no. 10 wood screw. There is no requirement for support battens or special fixings and no need for pre-drilling in to masonry providing additional flexibility and design freedom in room set-up and layout, and helping to ensure that future fixing needs are accommodated.

Refer to table 11 and 12 for guidance on the type and weight of fixtures that can be directly fixed to GypWall HABITO.

Refer to Service installations for further information.

Construction details

For GypWall HABITO construction details, refer to the construction details shown on page 134. For additional construction details, refer to GypWall CLASSIC, QUIET SF and QUIET sections of this White Book. For further typical or example details, please contact the Gyproc Technical Team.

Construction details - Single stud

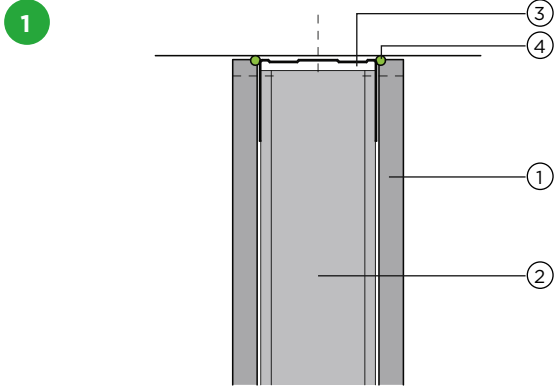

Head detail

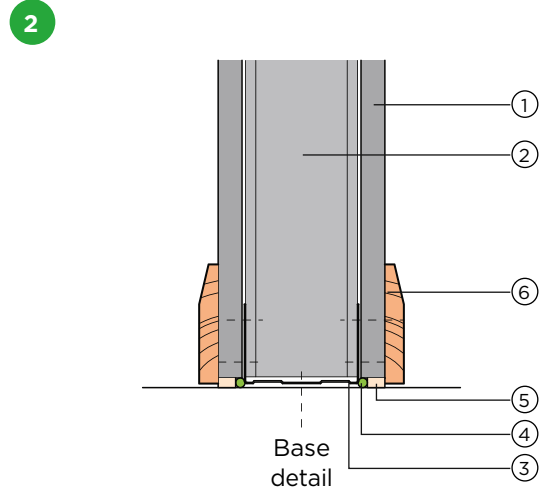

Base detail

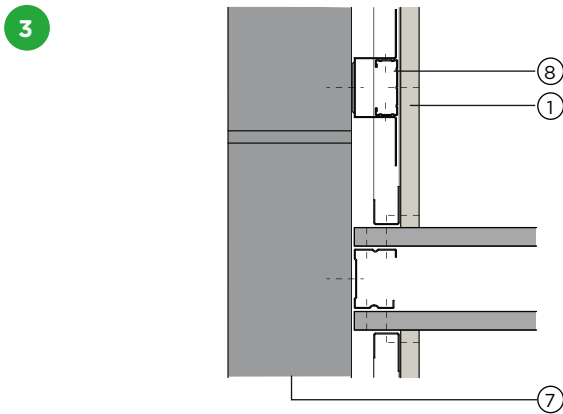

Junction detail with masonry and stop end detail

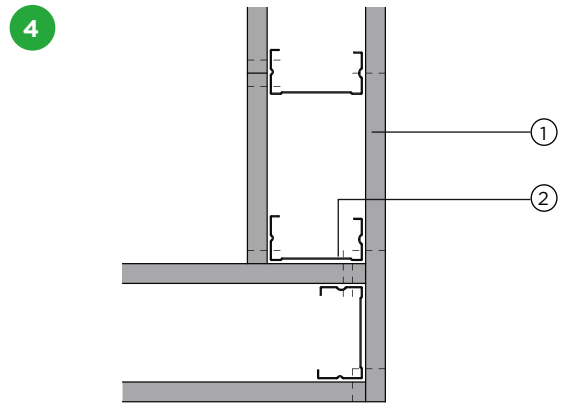

Corner detail for 70mm stud

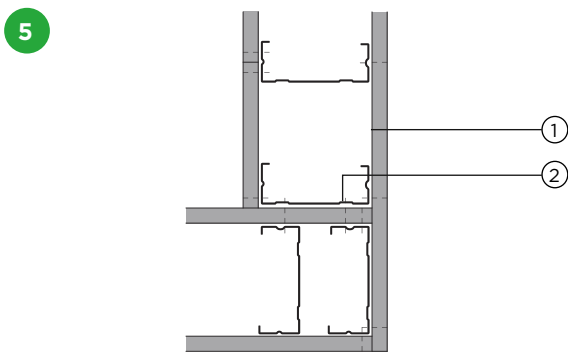

Corner detail for 92mm stud

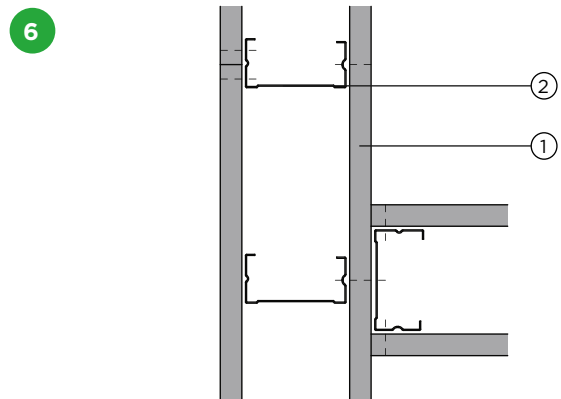

'T' junction detail for 70mm stud

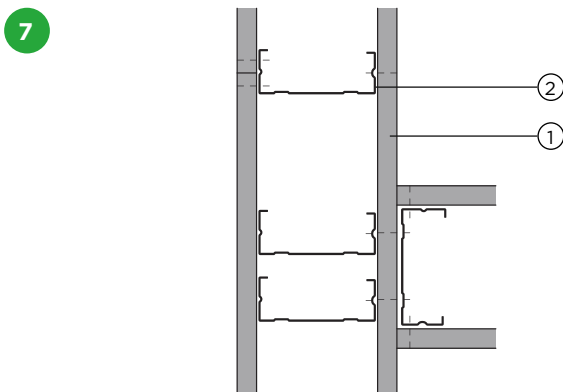

'T' junction detail for 92mm stud

1. Gyproc Habito
2. Gypframe 'C' Stud
3. Gypframe Deep Channel
4. Gyproc Sealant
5. Bulk fill with Gyproc Jointing Compound (where gap exceeds 5mm)
6. Skirting
7. Internal blockwork
8. GypLyner wall lining system

NB For more details refer to GypWall CLASSIC section on Page 66

Notes
